

- A) Distance de travail
Arbeitsabstand
Working distance
- D) Hauteur lentille additionnelle
Zusätzliche Linsenhöhe
Additional lens height
- 1) Caméra couleur
Farbkamera
Color camera
- 2) Câble vissé - 3m ou 5m
Angeschraubtes Kabel - 3m oder 5m
Screwed cable - 3m or 5m
- 3) Champ visuel (h) x (v)
Blickfeld (h) x (v)
Field of view (h) x (v)
- 4) Fixation
Befestigung
Clamping
- 5) Lentille additionnelle
Vorsatzlinse
Additional lens
- 6) Adaptateur
Adaptor 0.67X
Adapter
- 7) Tasseau ou couvercle
Befestigung oder Deckel
Mount or cover

5)	A	D
0.25X	336	11.9
0.50X	160	7.4
0.75X	107	6.5
1.00X	86	0
1.50X	50	9.2
2.00X	37	8.8

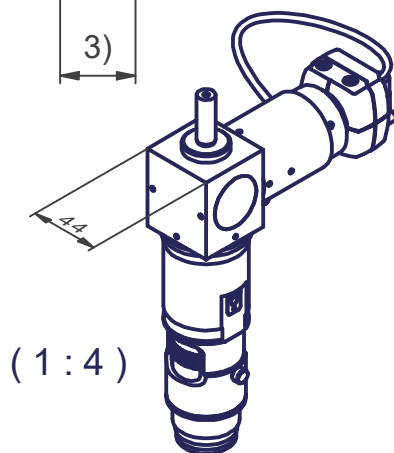

Mod. 1		Mod. 3		Origine		Echelle	Nom	M.Saam
Mod. 2		Mod. 4		Rempl.		1:2	Date	22.08.2018
Libellé				N° de plan		Catégorie		
OptiVID				MA 730-Z2-C-05...		\$20-0		
marcel - aubert - sa						Code article	N° de page	
						VID-...	1 / 1	